

Thermally insulated textile fire protection gate

Fibershield[®]-I



Stöbich.

Pioneer and Global market leader in building based-fire protection for 40 years.

Stöbich Brandschutz GmbH develops, manufactures and installs customised and serial structural fire protection solutions all around the globe, and is one of the most innovative and leading companies in the industry. Since 1980, this family operated company from Goslar has been leading the way in the field of protection systems against fire and smoke.

Alongside the conveyor systems division, Stöbich has become in the last 20 years a specialist and market leader in textile fire protection. By using the most State-of-the-art fabrics, we are able to create many different kinds of textile fire protection solution for a large number of applications, all of which stem from our production facility in Lower Saxony.





150 patents



11 Global innovations



70 countries

We offer solutions!



CURTAIN
OPEN



CURTAIN
HALF-CLOSED

Textile fire protection gate

Buildings are divided into fire and smoke compartments to prevent the uncontrolled spread of fire and smoke in case of fire. Wall and ceiling openings need to be closed effectively to prevent fire spreading to adjacent fire compartments and to create barriers to steer smoke. From an aesthetic point of view, conventional gate and door solutions impact significantly in the design of the building and the vision of the architects and planners.

Fire and smoke curtains that are fitted invisibly, for instance into suspended ceilings, offer planners and architects an attractive and versatile alternative to solid solutions. It stands for easy installation conditions, a light weight, low space requirements and enormous user benefit!

The all-round talents for preventive construction fire protection are not only highly popular for open room concepts, but these streamlined curtain systems are real problem-solvers in particular where space is tight.



space-saving

minimal space required for installation due to thin textile fabric



invisible

discreet integration in the planned building structure through the installation in a suspended ceiling



light

light weight due to textile concept



climate-friendly

resource-saving transport thanks to low weight



sustainable

Process and cutting optimisation thanks to joining of the individual layers in a modular system



ecological

solvent-free, full-surface coat

THERMALLY INSULATED FIRE PROTECTION GATE

Fire protection gates serve to close wall of ceiling openings in the event of a fire. Their constructional design (unrolling and folding equipment) and the use of various fabrics opens up a wide application spectrum and different protection objectives or classifications and time classes. Cases and guide rails of the flexible systems are combined almost invisibly into the building structure and offer lots of design freedom for complex open room concepts.

EI₁
EI₂

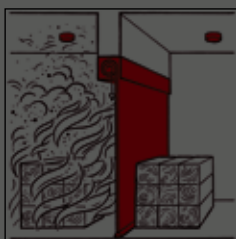

Thermally insulated
system

EI₁ 30 – EI₂ 120



Engineering and customer benefits

The Fibershield®-I (2017) system is the latest generation of thermally insulated textile fire protection gates by Stöbich.

Installation

The closure has the winding kinematics of a rolling gate and requires little construction space above a wall opening. Also, due to the patented lintel lock, the panels around the winding shaft can be dispensed with as an option. This enables the installation dimensions to be further reduced.

The multi-layer design of the fire protection curtain comprising alternating layers of insulating and cooling material allows the sparing use of the textiles and a reduction of the weight compared to conventional models.

Due to the low weight and construction space, the Fibershield®-I system is also ideal for modifying or refitting fire protection elements in existing buildings.

Design

The closures also allow unusual design options in new buildings to securely close extraordinarily large openings in case of fire.

The System Fibershield®-I can be integrated into the suspended ceiling almost invisibly. Parking positions next to the wall opening that usually need to be kept free for conventional fire protection elements can be used.

The focus of the further development of the Fibershield®-I is only very simple assembly. The guide rails have plug connectors and does not have any visible screw connections.

Sustainability

The textile curtain made of intumescent and endothermic textile layers is produced ecologically and without solvents. The use of identical textile layers in various arrangements allows cut-optimised production depending on the required fire protection classification.

A highly modern machine park, exactly coordinated production steps, and a precisely coordinated economy help us to CO₂-neutral production.

Design view

The textile curtain is on a winding shaft like a rolling gate. This ensures that only a relatively small space on the wall above the opening is required for installation. As the shielding element closes linear from top to bottom, only a relatively small closing area needs to be kept free.

The system can be designed with two different drive variants. The version that has tubular motors integrated into the winding shaft requires very little space, is low-maintenance and aesthetically attractive. Models with external chain drive offers

more play with respect to adjustment of the Opening and closing speed.

Both have drives thanks to an integrated locking device and closing speed control. Therefore, in case of fire, they will close by means of their own weight without any auxiliary energy.

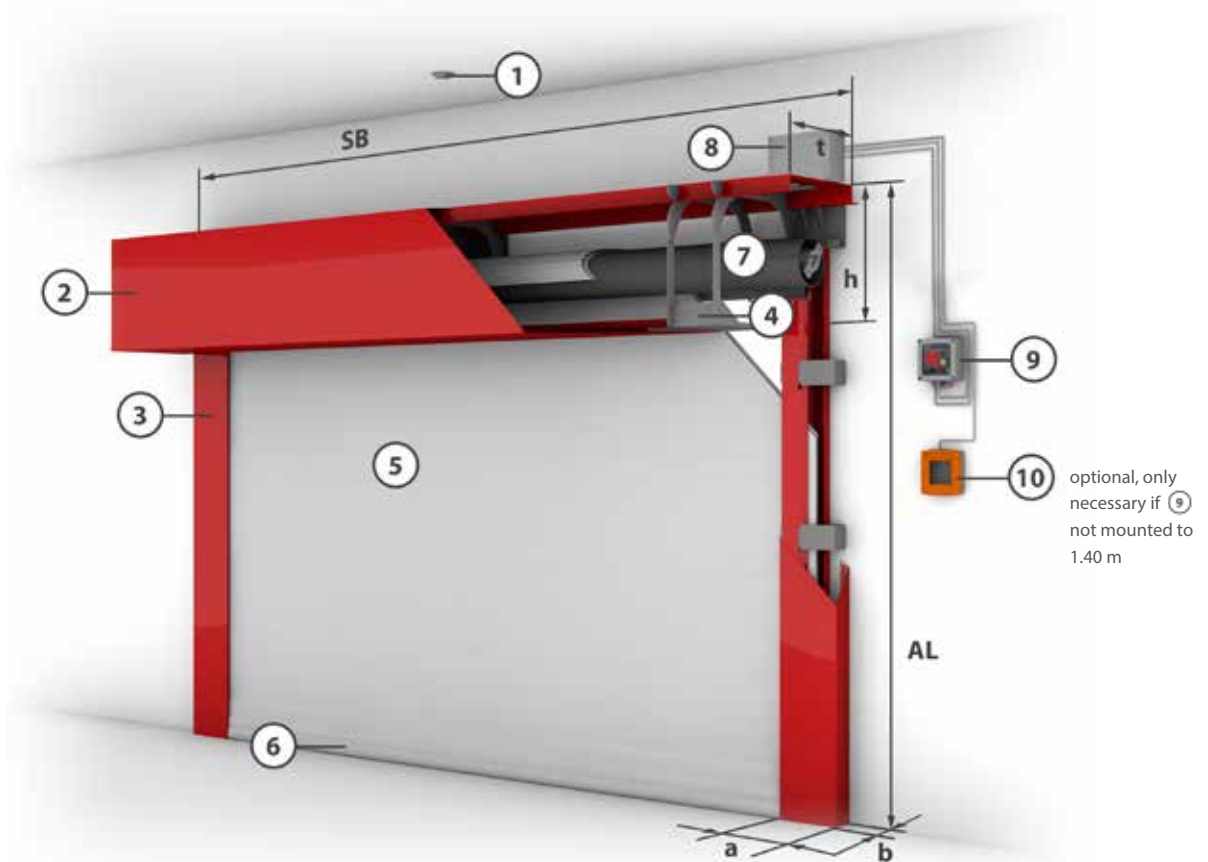

- 1 = Smoke detector 2 = Casing optional 3 = Guide rail 4 = Attachment bracket 5 = Textile 6 = Closing strip
 7 = Winder with tubular motor 8 = Control module 9 = Control with operating unit 10 = Manual control

optional, only necessary if 9 not mounted to 1.40 m

EI₂ 120

Installation variants

Housing:

Wall mounting

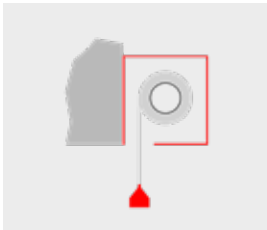

Wall mounting suspended ceiling with cover

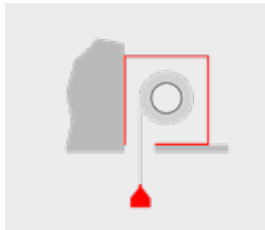

Wall mounting suspended ceiling without cover

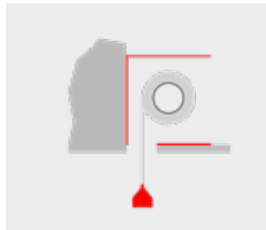

Guide rails:

Wall (flush)

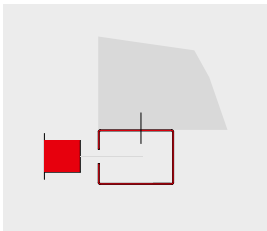

Wall

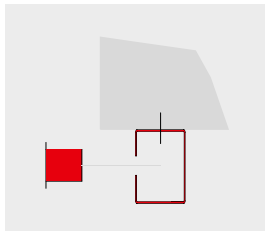

Information

Fibershield®-I
data sheet



There is more information in the data sheet

Stöbich dealers/sales partners:



International sales partners:

Armenia, Australia, Austria, Azerbaijan, Bahrain, Belarus, Belgium, Brazil, Bulgaria, Canada, Chile, China, Colombia, Croatia, Cyprus, Czech Republic, Denmark, Estonia, Finland, France, Georgia, Great Britain, Greece, Hong Kong, Hungary, Iceland, India, Iran, Ireland, Israel, Italy, Kazakhstan, Kyrgyzstan, Latvia, Lebanon, Liechtenstein, Lithuania, Luxembourg, Macedonia (FYROM), Malaysia, Moldavia, Netherlands, New Zealand, Norway, Paraguay, Peru, Poland, Portugal, Qatar, Romania, Russia, Saudi Arabia, Serbia, Singapore, Slovak Republic, Slovenia, Spain, Sweden, Switzerland, Taiwan, Tajikistan, Thailand, Turkey, Turkmenistan, UAE, Ukraine, Uruguay, USA, Uzbekistan ...

Om du behöver mer information eller vill ha en offert
kan du ringa till oss på telefon **+46 (0)70 751 24 08**
eller skicka ett mejl till info@doorsystem.se.

DOORSYSTEM
SWEDEN AB

Profilvägen 1 · S-246 43 Löddeköpinge · www.doorsystem.se